

Gusset
Side
View

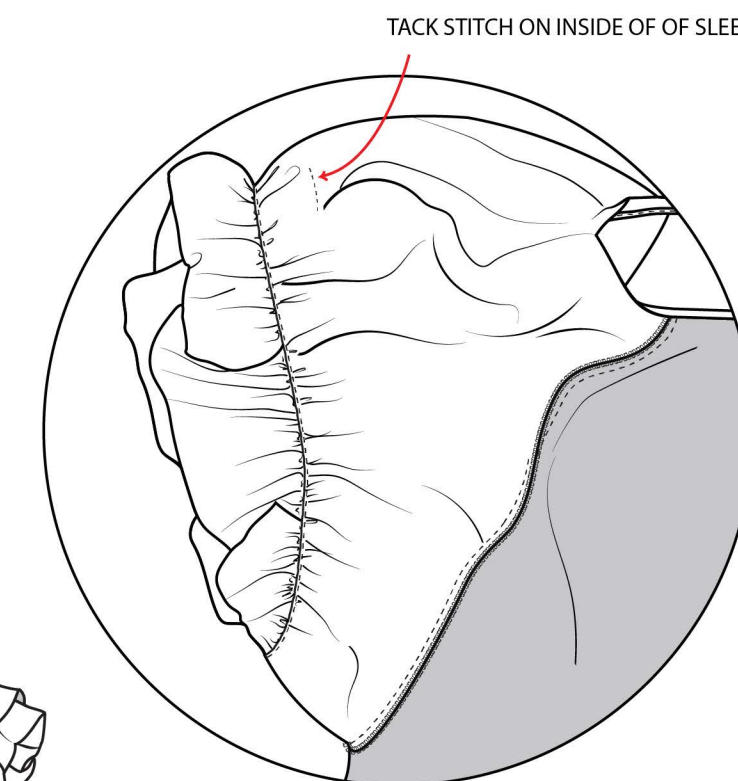

TACK STITCH ON INSIDE OF OF SLEEVE

INSIDE OUT VIEW OF SLEEVE

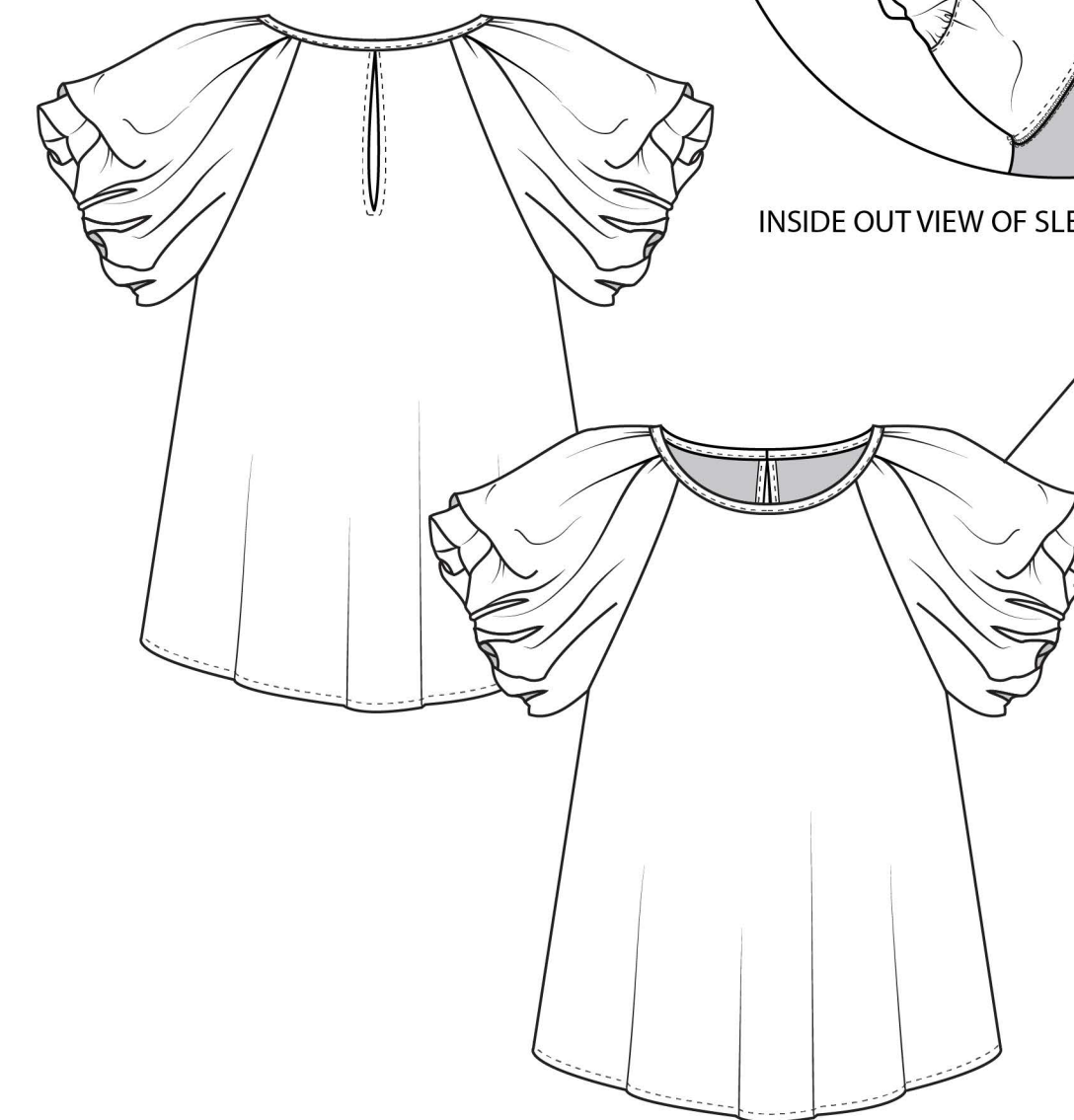
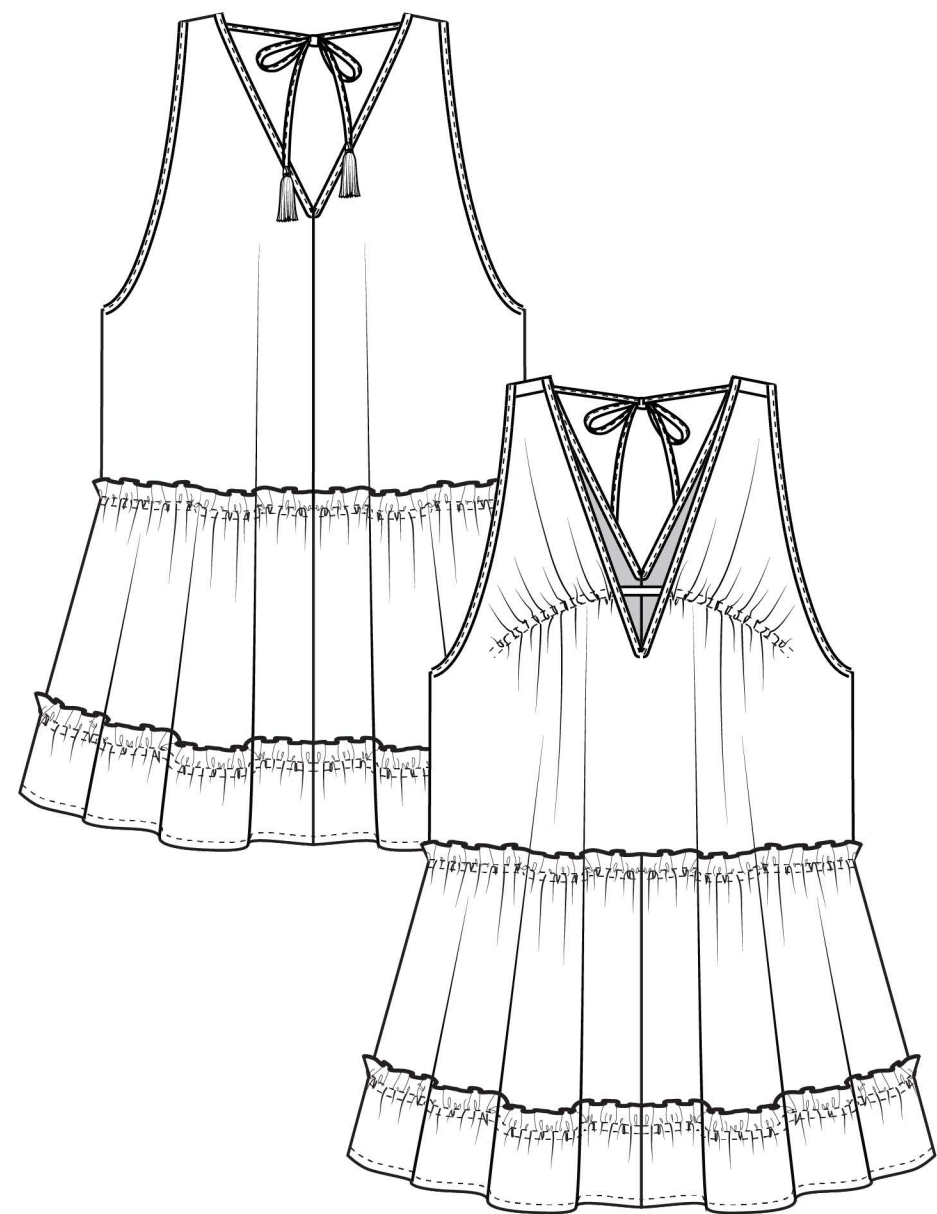
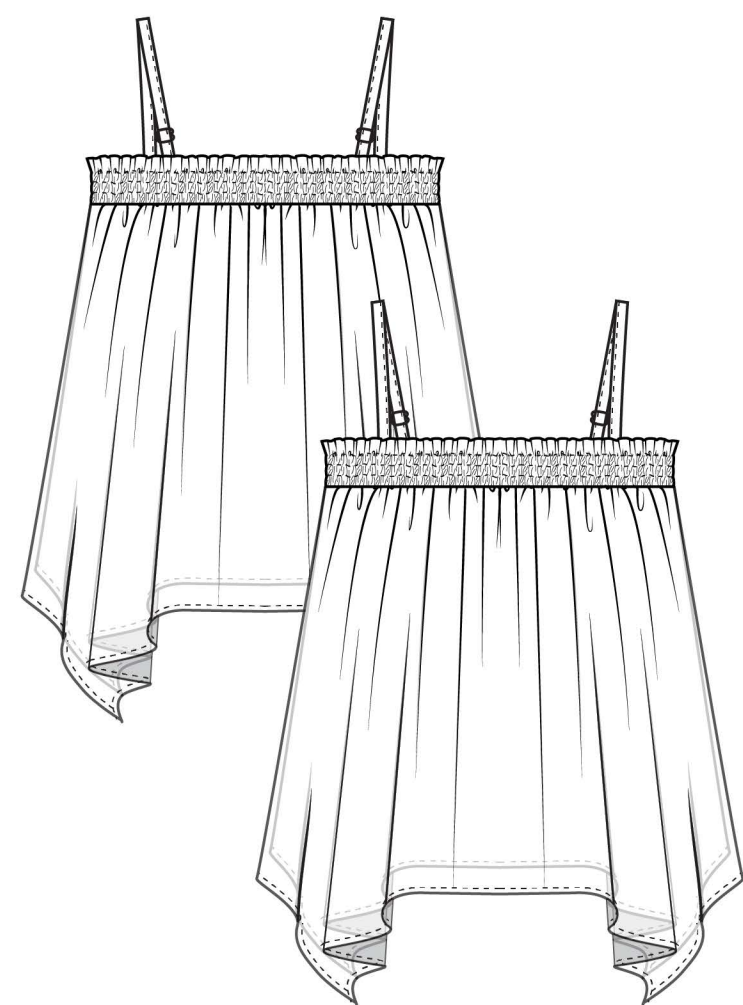
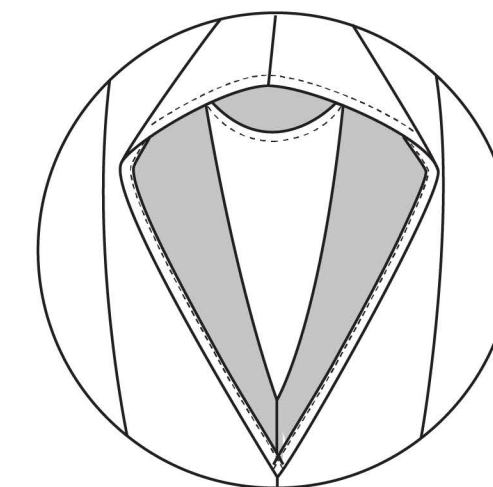
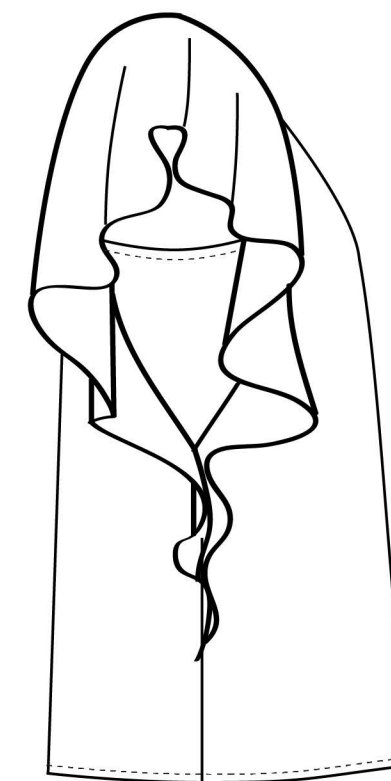
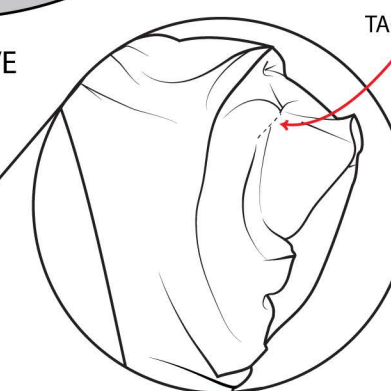

TACK STITCH

